

08.0405.05

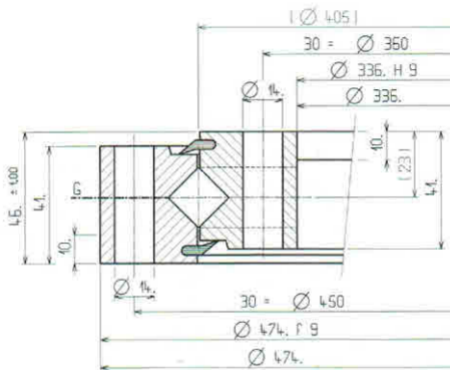

Бec 24 кр